



■ Features :

- Compliance to EN50155 railway standard
- 2:1 wide input range
- Protections: Short circuit / Overload / Over voltage / Over temperature / Input reverse polarity
- 4000VDC I/O isolation
- Cooling by free air convection
- Built-in constant current limiting circuit
- 1U low profile 39mm
- All using 105°C long life electrolytic capacitors
- LED indicator for power on
- 100% full load burn-in test
- 3 years warranty



**SPECIFICATION**

| MODEL                 |  | RSD-200B-12  | RSD-200B-24    | RSD-200B-48  | RSD-200C-12  | RSD-200C-24    | RSD-200C-48  | RSD-200D-12  | RSD-200D-24   | RSD-200D-48  |       |
|-----------------------|--|--|----------------|--------------|--------------|----------------|--------------|--------------|---------------|--------------|-------|
| OUTPUT                | DC VOLTAGE   | 12V  | 24V            | 48V          | 12V          | 24V            | 48V          | 12V          | 24V           | 48V          |       |
|                       | RATED CURRENT  | 16.7A  | 8.4A           | 4.2A         | 16.7A        | 8.4A           | 4.2A         | 16.7A        | 8.4A          | 4.2A         |       |
|                       | CURRENT RANGE  | 0 ~ 16.7A  | 0 ~ 8.4A       | 0 ~ 4.2A     | 0 ~ 16.7A    | 0 ~ 8.4A       | 0 ~ 4.2A     | 0 ~ 16.7A    | 0 ~ 8.4A      | 0 ~ 4.2A     |       |
|                       | RATED POWER  | 200.4W   | 201.6W         | 201.6W       | 200.4W       | 201.6W         | 201.6W       | 200.4W       | 201.6W        | 201.6W       |       |
|                       | RIPPLE & NOISE (max.) Note.2   | 120mVp-p   | 150mVp-p       | 180mVp-p     | 120mVp-p     | 150mVp-p       | 180mVp-p     | 120mVp-p     | 150mVp-p      | 180mVp-p     |       |
|                       | VOLTAGE TOLERANCE Note.3   | ±2.0%  | ±2.0%          | ±2.0%        | ±2.0%        | ±2.0%          | ±2.0%        | ±2.0%        | ±2.0%         | ±2.0%        | ±2.0% |
|                       | LINE REGULATION  | ±0.2%  | ±0.2%          | ±0.5%        | ±0.2%        | ±0.2%          | ±0.5%        | ±0.2%        | ±0.2%         | ±0.5%        |       |
|                       | LOAD REGULATION  | ±1.0%  | ±1.0%          | ±1.0%        | ±1.0%        | ±1.0%          | ±1.0%        | ±1.0%        | ±1.0%         | ±1.0%        |       |
|                       | SETUP, RISE TIME   | 800ms, 50ms at full load   |                |              |              |                |              |              |               |              |       |
| HOLD UP TIME (Typ.)   | B/C- type comply with S1 level @ full load, comply with S2 level @ 70% load ; D-type comply with S2 level @ full load  |  |                |              |              |                |              |              |               |              |       |
| INPUT                 | VOLTAGE RANGE  | CONTINUOUS   | 16.8 ~ 31.2VDC |              |              | 33.6 ~ 62.4VDC |              |              | 67.2 ~ 143VDC |              |       |
|                       |  | 1 SEC.   | 14.4 ~ 33.6VDC |              |              | 28.8 ~ 67.2VDC |              |              | 57.6 ~ 154VDC |              |       |
|                       | EFFICIENCY (Typ.)  | 89%  | 89%            | 89%          | 91%          | 91%            | 91%          | 91%          | 91%           | 91%          |       |
|                       | DC CURRENT (Typ.)  | 9.6A/24V   | 9.6A/24V       | 9.6A/24V     | 4.8A/48V     | 4.8A/48V       | 4.8A/48V     | 2.1A/110V    | 2.1A/110V     | 2.1A/110V    |       |
|                       | INRUSH CURRENT (Typ.)  | 45A/24VDC  |                |              | 45A/48VDC    |                |              | 45A/110VDC   |               |              |       |
| PROTECTION            | OVERLOAD   | 105 ~ 135% rated output power<br>Protection type : Constant current limiting, recovers automatically after fault condition is removed                  |                |              |              |                |              |              |               |              |       |
|                       | OVER VOLTAGE   | 13.8 ~ 16.2V   | 27.6 ~ 32.4V   | 55.2 ~ 64.8V | 13.8 ~ 16.2V | 27.6 ~ 32.4V   | 55.2 ~ 64.8V | 13.8 ~ 16.2V | 27.6 ~ 32.4V  | 55.2 ~ 64.8V |       |
|                       | OVER TEMPERATURE   | 90°C ±5°C (TSW1) detect on heatsink of power transistor<br>Protection type : Shut down o/p voltage, recovers automatically after temperature goes down |                |              |              |                |              |              |               |              |       |
| ENVIRONMENT           | WORKING TEMP.  | -40 ~ +55°C (no derating) ; +70°C @ 60% load by free air convection ; +70°C no derating with external base plate, TX class compliance                  |                |              |              |                |              |              |               |              |       |
|                       | WORKING HUMIDITY   | 5 ~ 95% RH non-condensing  |                |              |              |                |              |              |               |              |       |
|                       | STORAGE TEMP., HUMIDITY  | -40 ~ +85°C, 10 ~ 95% RH   |                |              |              |                |              |              |               |              |       |
|                       | TEMP. COEFFICIENT  | ±0.03%/°C (0 ~ 50°C)   |                |              |              |                |              |              |               |              |       |
|                       | VIBRATION  | 10 ~ 500Hz, 5G 10min./1cycle, 60min. each along X, Y, Z axes ; Mounting : compliance to IEC61373   |                |              |              |                |              |              |               |              |       |
| SAFETY & EMC (Note 4) | SAFETY STANDARDS   | Meet IEC60950-1(LVD)   |                |              |              |                |              |              |               |              |       |
|                       | WITHSTAND VOLTAGE  | I/P-O/P:4KVDC I/P-FG:2.5KVDC O/P-FG:2.5KVDC  |                |              |              |                |              |              |               |              |       |
|                       | ISOLATION RESISTANCE   | I/P-O/P, I/P-FG, O/P-FG:100M Ohms / 500VDC / 25°C / 70% RH   |                |              |              |                |              |              |               |              |       |
|                       | EMC EMISSION   | Compliance to EN55022 (CISPR22) Conduction Emission: Class A, Radiation Emission: Class B ; EN50155(EN50121-3-2)                                       |                |              |              |                |              |              |               |              |       |
|                       | EMC IMMUNITY   | Compliance to EN61000-4-2,3,4,5,6,8, light industry level, criteria A ; EN50121-3-2  |                |              |              |                |              |              |               |              |       |
| RAILWAY STANDARD      | Meet EN50155 / IEC60571, including IEC61373 for shock & vibration, EN50121-3-2 for EMC   |  |                |              |              |                |              |              |               |              |       |
| OTHERS                | MTBF   | 218.2K hrs min. MIL-HDBK-217F (25°C)   |                |              |              |                |              |              |               |              |       |
|                       | DIMENSION  | 191*86*40mm (L*W*H)  |                |              |              |                |              |              |               |              |       |
|                       | PACKING  | 0.94Kg; 12pcs/12.3Kg/0.8CUFT   |                |              |              |                |              |              |               |              |       |
| NOTE                  | <p>1. All parameters NOT specially mentioned are measured at 24,48,110VDC input, rated load and 25°C of ambient temperature.</p> <p>2. Ripple &amp; noise are measured at 20MHz of bandwidth by using a 12" twisted pair-wire terminated with a 0.1uf &amp; 47uf parallel capacitor.</p> <p>3. Tolerance : includes set up tolerance, line regulation and load regulation.</p> <p>4. The power supply is considered a component which will be installed into a final equipment. The final equipment must be re-confirmed that it still meets EMC directives.</p> |  |                |              |              |                |              |              |               |              |       |

## Mechanical Specification

Case No.203A Unit:mm

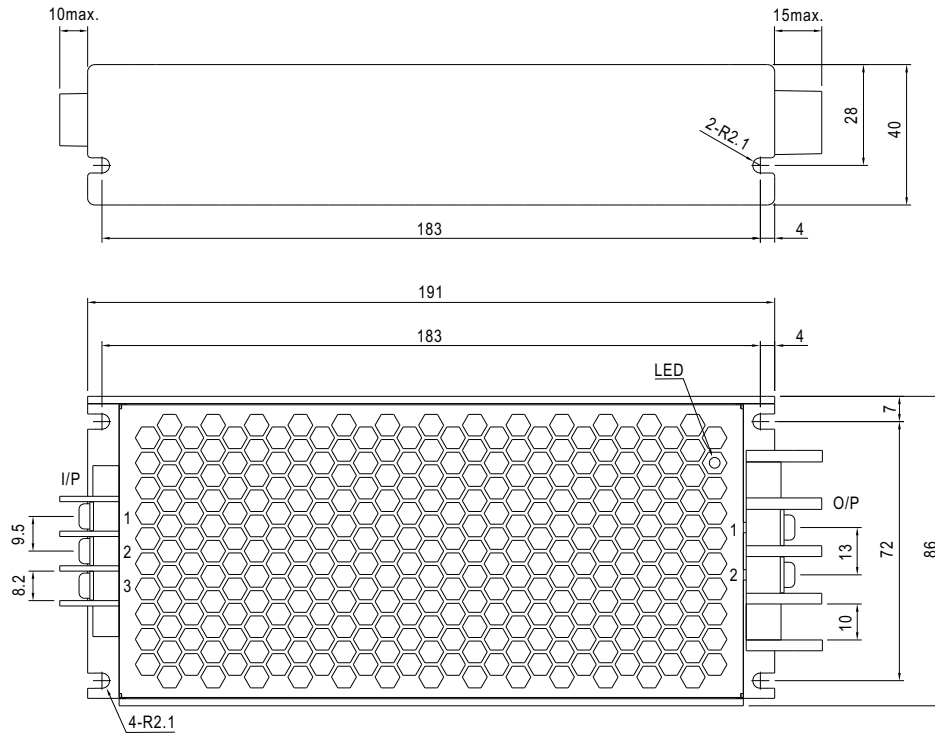

Input Terminal Pin No. Assignment :

| Pin No. | Assignment  |
|---------|-------------|
| 1       | DC INPUT V+ |
| 2       | DC INPUT V- |
| 3       | FG $\perp$  |

Output Terminal Pin No. Assignment :

| Pin No. | Assignment   |
|---------|--------------|
| 1       | DC OUTPUT -V |
| 2       | DC OUTPUT +V |

## Block Diagram

fosc : 130KHz

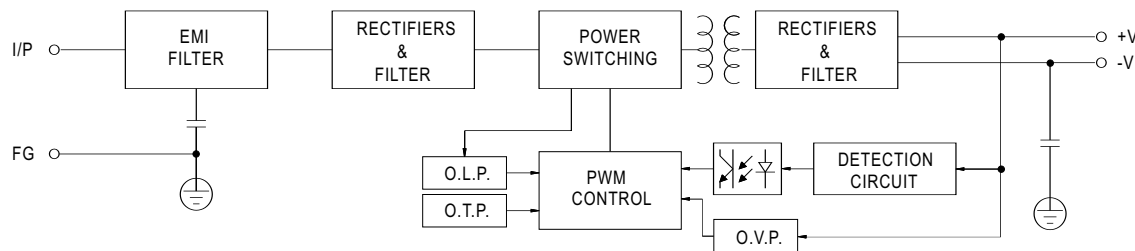

## Input Fuse

There are one or two fuses connected in series to the positive input line, which are used to protect against abnormal surge. Fuse specifications of each model are shown as below.

| Type | Fuse Type | Reference and Rating       |
|------|-----------|----------------------------|
| B    | Time-Lag  | 2*Conquer UDA-A, 10A, 250V |
| C    | Time-Lag  | Conquer UDA-A, 10A, 250V   |
| D    | Time-Lag  | Conquer UDA-A, 5A, 250V    |

## Input Reverse Polarity Protection

There is a MOSFET connected in series to the negative input line. If the input polarity is connected reversely, the MOSFET opens and there will be no output to protect the unit.

## Input Range and Transient Ability

The series has a wide range input capability. Within  $\pm 30\%$  of rated input voltage, it can be executed at full-load operation and operate properly; with  $\pm 40\%$  of rated input voltage, it can withstand that for 1 second.

## Input Under-Voltage Protection

If input voltage drops below  $V_{imin}$ , the internal control IC shuts down and there is no output voltage. It recovers automatically when input voltage reaches above  $V_{imin}$ , please refer to the cruve below.

RSD-200B-24

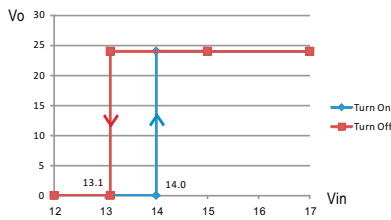

RSD-200C-24

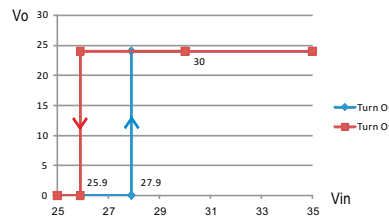

RSD-200D-24

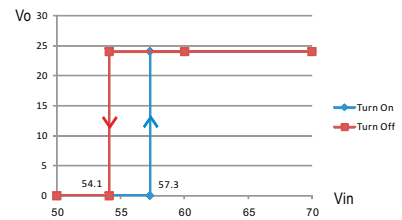

## Inrush Current

Inrush current is suppressed by a resistor during the initial start-up, and then the resistor is bypassed by a MOSFET to reduce power consumption after accomplishing the start-up.

## Hold-up Time

D type is in compliance with S2 level, while B and C types are in compliance with S1 level at full load output condition. To fulfil the requirements of S2 level, B and C types require de-rating their output load to 70%, please refer to the curve diagrams below.

RSD-200B-12

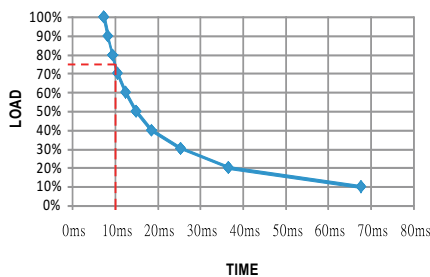

RSD-200B-24

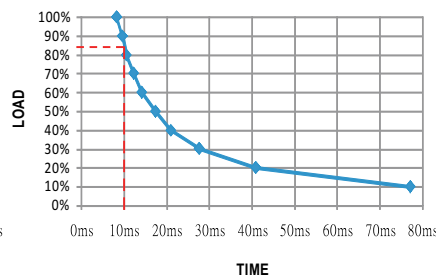

RSD-200B-48

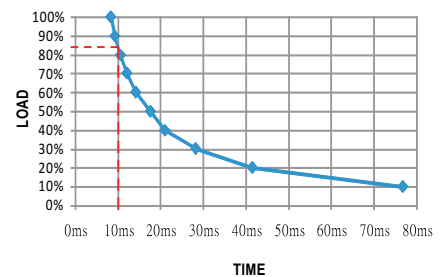

RSD-200C-12

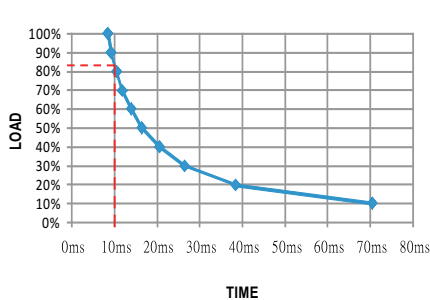

RSD-200C-24

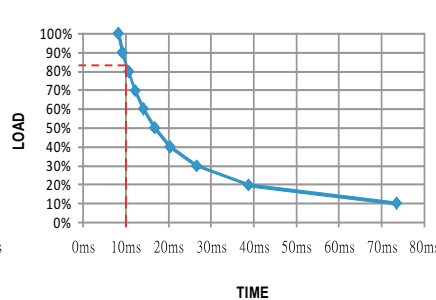

RSD-200C-48

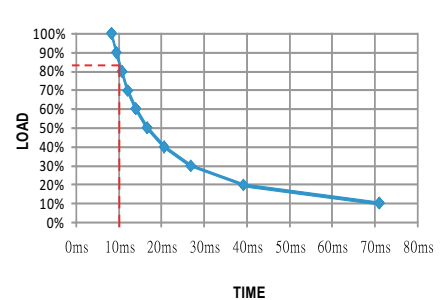

## Output Voltage Adjustment

This function is optional, which the standard product does not have it. If you do need the function, please contact MW for details.

## Efficiency vs Load & Vin Curve

The efficiency vs load & Vin curves of each model are shown as below.

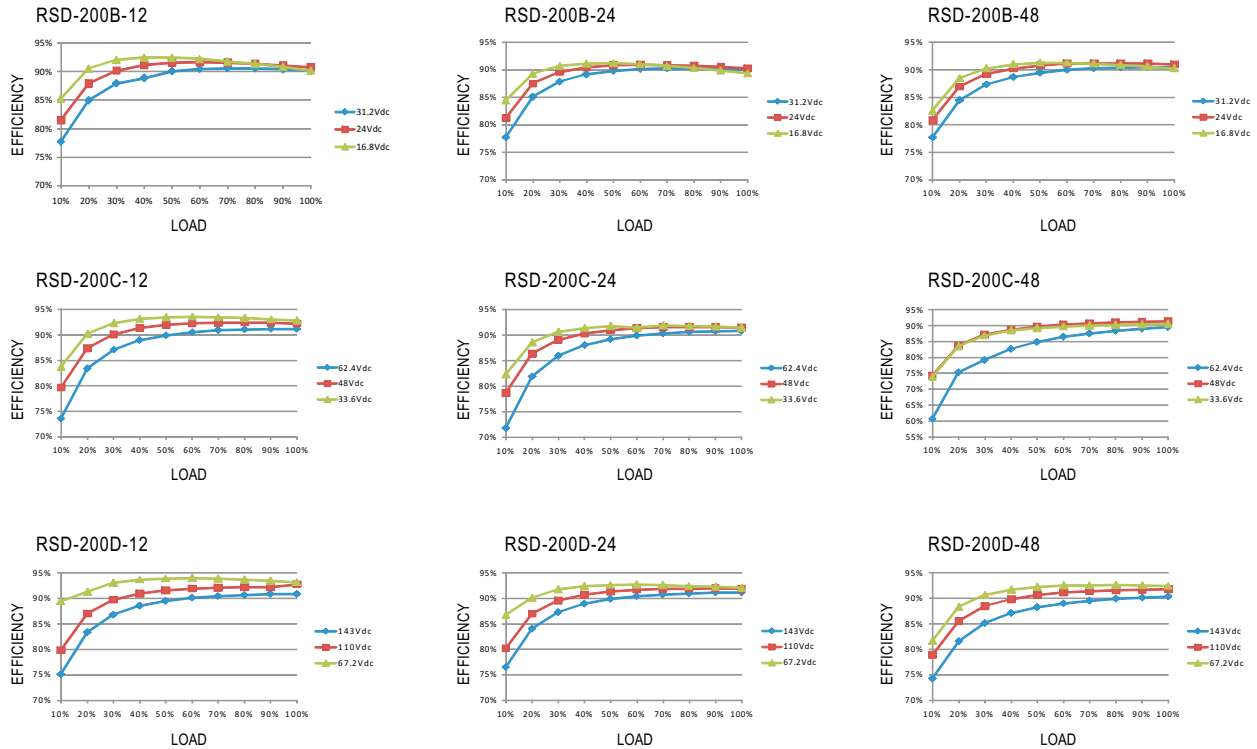

## Parallel and Series Connection

### A. Operation in Parallel

Since RSD-200 series don't have built-in parallel circuit, it can only use external circuits to achieve the redundant operation but not increase the current rating.

1. Add a diode at the positive-output of each power supply (as shown as below), the current rating of the diode should be larger than the maximum output current rating and attached to a suitable heat sink. This is only for redundant use (increase the reliability of the system) and users have to check suitability of the circuit by themselves.

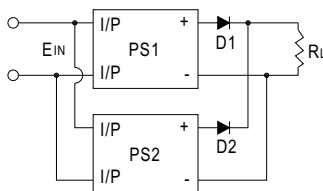

2. When using S.P.S. in parallel connection, the leakage current will increase at the same time. This could pose as a shock hazard for the user. So please contact the supplier if you have this kind of application.

### B. Operation in Series

RSD-200 can be operated in series. Here are the methods of doing it:

1. Positive and negative terminals are connected as shown as below. According to the connection, you can get the positive and negative output voltages for your loads.

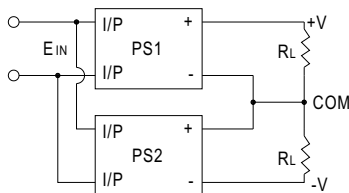

2. Increase the output voltage (current does not change). Because RSD-200 series have no reverse blocking diode in the unit, you should add an external blocking diode to prevent the damage of every unit while starting up. The voltage rating of the external diode should be larger than  $V1+V2$  (as shown as below).

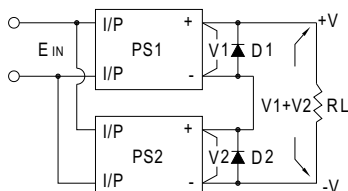

## Overload Protection

If the output draw up to 105~135% of its output power rating, the converter will go into overload protection which is constant current mode. After the faulty condition is removed, it will recover automatically. Please refer to the diagram below for the detail operation characteristic. Please note that it's not suitable to operate within the overload region continuously, or it may cause to over temperature and reduce the life of the power supply unit or even damage it.

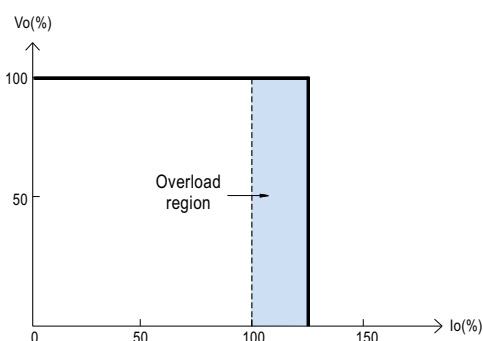

## Over Voltage Protection

The converter shuts off to protect itself when the output voltage drawn exceeds 115~135% of its output rating. It must be repowered on to recover.

## Over Temperature Protection

The converter shuts off to protect itself when the built-in temperature sensor mounted on the heat sink of transistors senses a high temperature. The output recovers automatically if the temperature drops below the limit.

## LED Indicator

Equipped with a built-in LED indicator, the converter provides an easy way for users to check its condition through the LED indicator.

Green : normal operation; No signal: no power or failure.

## Derating Curve

### a. Single unit operation

If the unit is without an iron plate mounted on its bottom, the maximum ambient temperature for the unit will be 55°C as operating under full load condition. It requires de-rating output current when ambient temperature is between 55-70°C, please refer to the de-rating curve as below.

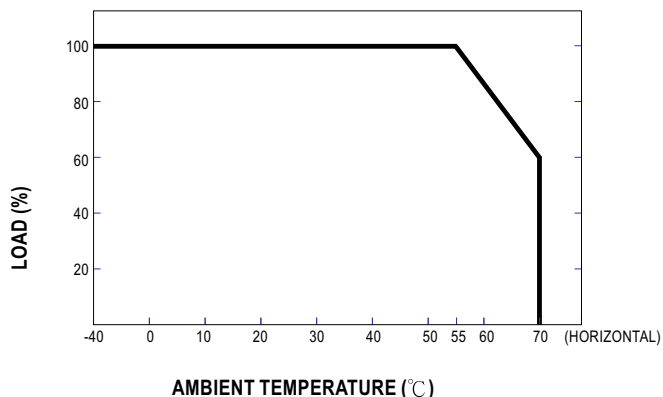

Suitable installation methods are shown as below. Since RSD-200 is a semi-potted model, its thermal performances for the following installation methods are similar and share the same derating curve.

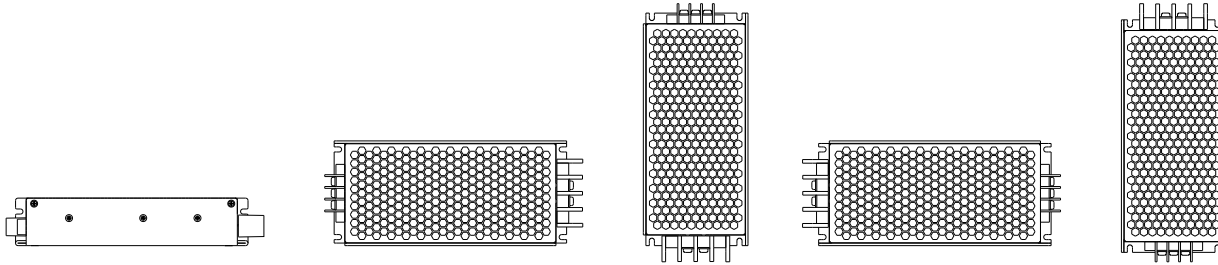

**b. Operate with additional iron plate**

If it is necessary to fulfil the requirements of EN50155 TX level that operate the unit fully-loaded at 70°C, RSD-200 series must be installed onto an iron plate on the bottom. The size of the suggested iron plate is shown as below. In order for optimal thermal performance, the iron plate must have an even & smooth surface and RSD-200 series must be firmly mounted at the center of the iron plate.

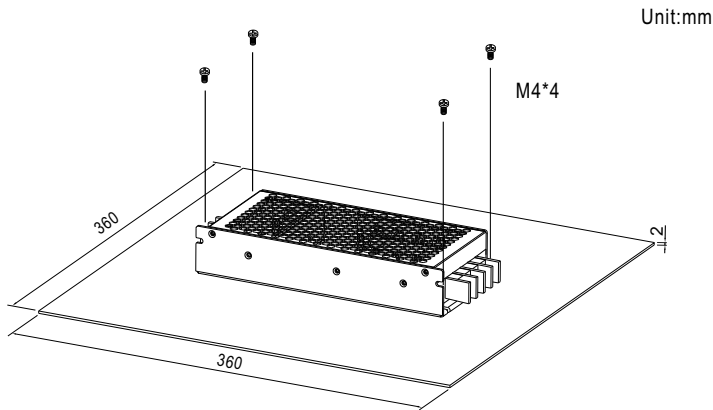

The load vs ambient temperature curve is shown as below.

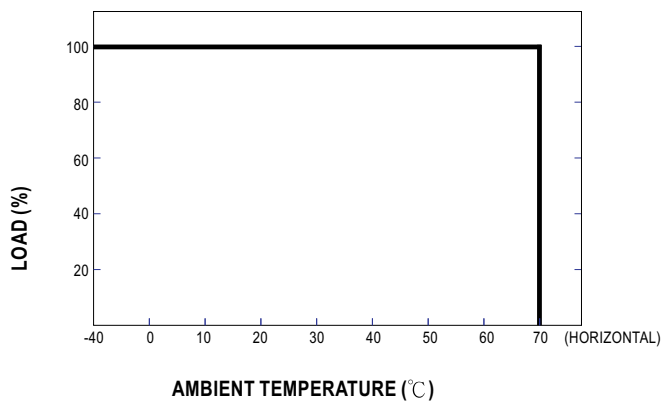

Suitable installation methods are shown as below. Since RSD-200 is a semi-potted model, its thermal performances for the following installation methods are similar and share the same derating curve.

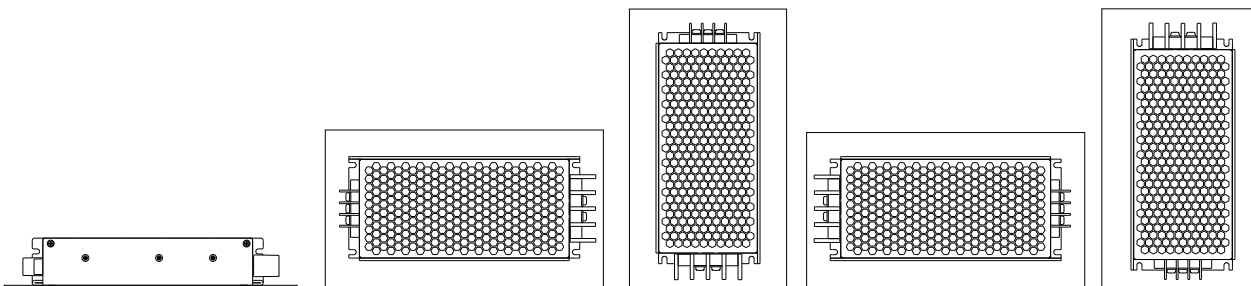

**■ Immunity to Environmental Conditions**

| Test method                  | Standard  | Test conditions   | Status    |
|------------------------------|---|---|-----------|
| Cooling Test                 | EN 50155 section 12.2.3 (Column 2, Class TX)<br>EN 60068-2-1  | Temperature: -40°C<br>Dwell Time: 2 hrs/cycle                       | No damage |
| Dry Heat Test                | EN 50155 section 12.2.4 (Column 2, Class TX)<br>EN 50155 section 12.2.4 (Column 3, Class TX & Column 4, Class TX)<br>EN 60068-2-2 | Temperature: 70°C / 85°C<br>Duration: 6 hrs / 10min                 | PASS      |
| Damp Heat Test, Cyclic       | EN 50155 section 12.2.5<br>EN 60068-2-30  | Temperature: 25°C~55°C<br>Humidity: 90%~100% RH<br>Duration: 48 hrs | PASS      |
| Vibration Test               | EN 50155 section 12.2.11<br>EN 61373  | Temperature: 19°C<br>Humidity: 65%<br>Duration: 10 mins             | PASS      |
| Increased Vibration test     | EN 50155 section 12.2.11<br>EN 61373  | Temperature: 19°C<br>Humidity: 65%<br>Duration: 5 hrs               | PASS      |
| Shock Test                   | EN 50155 section 12.2.11<br>EN 61373  | Temperature: 21±3°C<br>Humidity: 65±5%<br>Duration: 30ms*18         | PASS      |
| Low Temperature Storage Test | EN 50155 section 12.2.3 (Column 2, Class TX)<br>EN 60068-2-1  | Temperature: -40°C<br>Dwell Time: 16 hrs                            | PASS      |