

MR9232 series

**(92 x 92 x 32 mm)**

3.62 x 3.62 x 1.26 inches

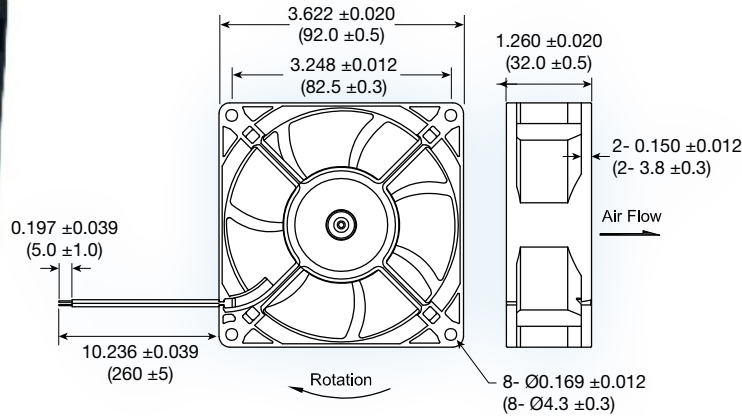
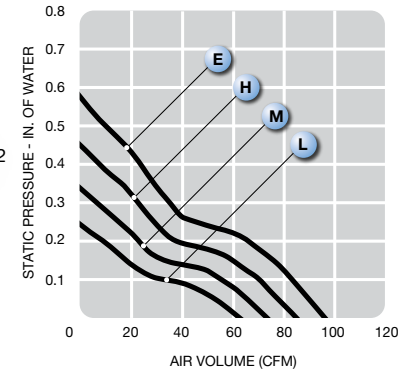

Features: soft start, polarity protection, auto-restart

Operating Voltage: 12 or 24 VDC

Construction: UL94V-0 plastic impeller and frame

Bearing option: ball bearing or sleeve

Air Flow: air exhaust over struts

Options: tachometer output or locked rotor alarm signal; PWM speed control

Model No.	Rated Voltage VDC	Current A		Speed RPM	Air Volume		Max. Static Pressure (H ₂ O)		Sound Noise dba	Weight g
		12	24		M ³ /Min.	CFM	MM	INCH		
MR9232L	12/24	0.31	0.16	3,200	1.75	62	6.16	0.24	43.0	150
MR9232M	12/24	0.46	0.23	3,800	2.07	74	8.61	0.34	48.8	150
MR9232H	12/24	0.60	0.30	4,400	2.39	85	11.46	0.45	49.7	150
MR9232E	12/24	0.98	0.49	5,000	2.71	96	14.72	0.58	52.8	150