

MR8032 series

**(80 x 80 x 32 mm)**

3.15 x 3.15 x 1.26 inches

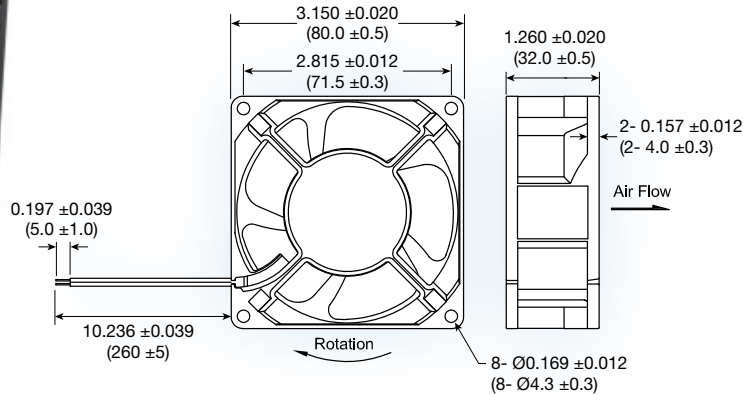
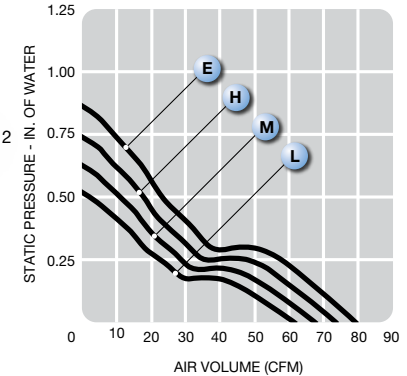

Features: soft start, polarity protection, auto-restart

Operating Voltage: 12 or 24 VDC

Construction: UL94V-0 plastic impeller and frame

Bearing option: ball bearing or sleeve

Air Flow: air exhaust over struts

Options: tachometer output or locked rotor alarm signal; PWM speed control

Model No.	Rated Voltage VDC	Current A		Speed RPM	Air Volume		Max. Static Pressure (H ₂ O)		Sound Noise dbA	Weight g
		12	24		M ³ /Min.	CFM	MM	INCH		
MR8032L	12/24	0.42	0.21	5,000	1.72	61	13.55	0.53	41.6	144
MR8032M	12/24	0.54	0.27	5,500	1.89	67	16.34	0.64	45.2	144
MR8032H	12/24	0.70	0.35	6,000	2.06	73	19.39	0.76	48.6	144
MR8032E	12/24	0.86	0.43	6,500	2.23	79	22.70	0.89	50.4	144