

**■ Features**

- **Global certificates**
- Universal AC input / Full range
- 3 pole AC inlet IEC320-C14, Class I power unit
- Built-in active PFC function
- No load power consumption < 0.15W
- **Energy efficiency Level VI**
- Comply with EISA 2007/DoE, NRCAN, Korea K-MEPS, AU/NZ MEPS, EU ErP and CoC Version 5
- Protections: Short circuit / Overload / Over voltage / Over temperature
- Fully enclosed plastic case
- -30~+70°C wide range working temperature
- LED indicator for power on
- 3 years warranty

**■ Applications**

- Consumer electronic devices
- Telecommunication devices
- Office facilities
- Industrial equipments

**■ Description**

GST120A is a highly reliable, 120W desktop style single-output green adaptor series. This product is a class I power unit (with FG), equipped with a standard IEC320-C14 AC inlet and adopting the input range from 85VAC to 264VAC. The entire series supplies different models with output voltages ranging between 12VDC and 48VDC that can satisfy the demands for various types of consumer electronic devices.

With the efficiency up to 91% and the extremely low no-load power consumption below 0.15W, GST120A is compliant with USA EISA 2007/DoE, Canada NRCAN, Australia and New Zealand MEPS, Korea K-MEPS, EU ErP and Code of Conduct (CoC) Version 5. The supreme feature allows the adaptor to save the energy when it is either under the operating mode or the standby mode. The entire series utilizes the 94V-0 flame retardant plastic case. GST120A is certified for the international safety regulations.

**■ Model Encoding**

**GST 120A 12 -R7B**

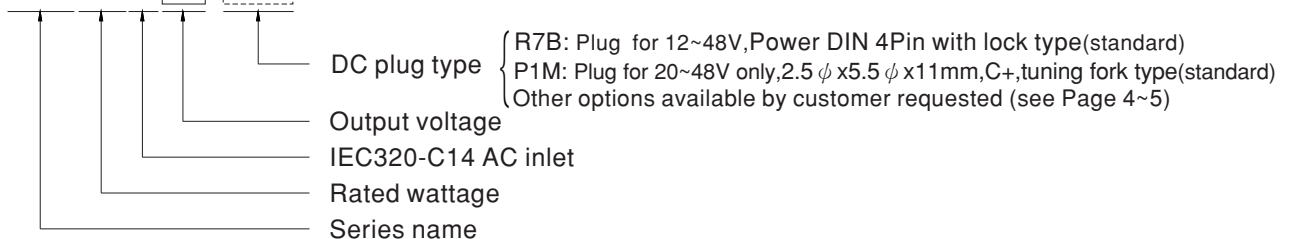

**SPECIFICATION**

ORDER NO.		GST120A12-R7B	GST120A15-R7B	GST120A20- <input type="checkbox"/> <input type="checkbox"/> =R7B,P1M	GST120A24- <input type="checkbox"/> <input type="checkbox"/> =R7B,P1M	GST120A48- <input type="checkbox"/> <input type="checkbox"/> =R7B,P1M	
OUTPUT	SAFETY MODEL NO.	GST120A12	GST120A15	GST120A20	GST120A24	GST120A48	
	DC VOLTAGE	12V	15V	20V	24V	48V	
	RATED CURRENT	8.5A	7A	6A	5A	2.5A	
	CURRENT RANGE	0 ~ 8.5A	0 ~ 7A	0 ~ 6A	0 ~ 5A	0 ~ 2.5A	
	RATED POWER (max.)	102W	105W	120W	120W	120W	
	RIPPLE & NOISE (max.) Note.2	120mVp-p	120mVp-p	150mVp-p	180mVp-p	200mVp-p	
	VOLTAGE TOLERANCE Note.3	±5.0%	±5.0%	±5.0%	±3.0%	±2.5%	
	LINE REGULATION Note.4	±1.0%	±1.0%	±1.0%	±1.0%	±1.0%	
	LOAD REGULATION	±5.0%	±5.0%	±4.0%	±3.0%	±2.5%	
	SETUP, RISE TIME Note.5	2000ms, 30ms / 230VAC      2500ms, 30ms / 115VAC at full load					
HOLD UP TIME (Typ.)	20ms / 230VAC      20ms / 115VAC at full load						
INPUT	VOLTAGE RANGE Note.6	85 ~ 264VAC    120 ~ 370VDC					
	FREQUENCY RANGE	47 ~ 63Hz					
	POWER FACTOR (Typ.)	PF>0.93 / 230VAC    PF>0.97 / 115VAC at full load					
	EFFICIENCY (Typ.)	R7B	88.5%	89%	90%	90.5%	91%
		P1M	-----	-----	89%	89.5%	90.5%
	AC CURRENT	1.4A / 115VAC    0.7A / 230VAC					
	INRUSH CURRENT (max.)	Cold start    35 / 115AC    70A / 230VAC					
LEAKAGE CURRENT(max.)	0.75mA / 240VAC						
PROTECTION	OVERLOAD	105 ~ 160% rated output power Protection type : Hiccup mode, recovers automatically after fault condition is removed					
	OVER VOLTAGE	105 ~ 135% rated output voltage Protection type : Shut down o/p voltage, re-power on to recover					
	OVER TEMPERATURE	Shut down o/p voltage, re-power on to recover					
ENVIRONMENT	WORKING TEMP.	-30 ~ +70°C (Refer to "Derating Curve")					
	WORKING HUMIDITY	20% ~ 90% RH non-condensing					
	STORAGE TEMP., HUMIDITY	-40 ~ +85°C, 10 ~ 95% RH non-condensing					
	TEMP. COEFFICIENT	±0.03% / °C (0~45°C)					
	VIBRATION	10 ~ 500Hz, 2G 10min./1cycle, period for 60min. each along X, Y, Z axes					
SAFETY & EMC (Note. 8)	SAFETY STANDARDS Note. 7	UL60950-1, CSA C22.2, TUV EN60950-1, BSMI CNS14336, CCC GB4943, PSE J60950-1, AS/NZS 60950.1 , BIS IS13252, KC K60950-1, EAC TP TC 004 approved; SIRIM MS IEC60950-1 (optional) approved					
	WITHSTAND VOLTAGE	I/P-O/P: 3KVAC					
	ISOLATION RESISTANCE	I/P-O/P:100M Ohms / 500VDC / 25°C / 70% RH					
	EMC EMISSION	Parameter	Standard			Test Level / Note	
		Conducted emission	EN55032(CISPR32),FCC PART 15 / CISPR22 CAN ICES-3(B)/NMB-3(B),CNS13438,GB17625.1 EAC TP TC 020_MSIP KN32			Class B	
		Radiated emission	EN55032(CISPR32),FCC PART 15 / CISPR22 CAN ICES-3(B)/NMB-3(B),CNS13438,GB17625.1 EAC TP TC 020_MSIP KN32			Class B	
		Harmonic current	EN61000-3-2,GB9254			Class A	
		Voltage flicker	EN61000-3-3			-----	
	EMC IMMUNITY	Parameter	Standard			Test Level /Note	
		ESD	EN61000-4-2			Level 4, 15KV air; Level 4, 8KV contact	
		RF field susceptibility	EN61000-4-3			Level 2, 3V/m	
		EFT bursts	EN61000-4-4			Level 2, 1KV	
		Surge susceptibility	EN61000-4-5			Level 3, 1KV/Line-Line , 2KV/Line-FG	
		Conducted susceptibility	EN61000-4-6			Level 2, 3V	
		Magnetic field immunity	EN61000-4-8			Level 2, 3A/m	
Voltage dips , interruption		EN61000-4-11			>95% dip 0. 5 periods, 30% dip 25 periods, >95% interruptions 250 periods		
OTHERS	MTBF	368.75K hrs min. MIL-HDBK-217F(25°C)					
	DIMENSION	167*67*35mm (L*W*H)					
	PACKING	0.62Kg; 20pcs/13.4Kg/0.9CUFT					
CONNECTOR	PLUG	See page 4~5 ; Other type available by customer requested					
	CABLE	See page 4~5 ; Other type available by customer requested					
NOTE	<ol style="list-style-type: none"> <li>All parameters are specified at 230VAC input, rated load, 25°C 70% RH ambient.</li> <li>Ripple &amp; noise are measured at 20MHz by using a 12" twisted pair terminated with a 0.1µf &amp; 47µf capacitor.</li> <li>Tolerance: includes set up tolerance, line regulation, load regulation.</li> <li>Line regulation is measured from low line to high line at rated load.</li> <li>Length of set up time is measured at first cold start. Turning ON/OFF the power supply may lead to increase of the set up time.</li> <li>Derating may be needed under low input voltage. Please check the derating curve for more details.</li> <li>The demand for Malaysia safety is processed with the order no. GST120A <input type="checkbox"/> -SIRIM by request. Please contact MEAN WELL for details.</li> <li>The power supply is considered as an independent unit, but the final equipment still need to re-confirm that the whole system complies with the EMC directives. For guidance on how to perform these EMC tests, please refer to "EMI testing of component power supplies." (as available on <a href="http://www.meanwell.com">http://www.meanwell.com</a>)</li> </ol>						

**Derating Curve**

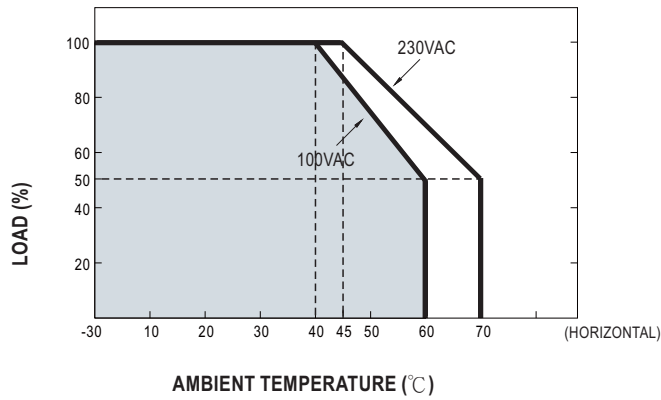

**Static Characteristics**

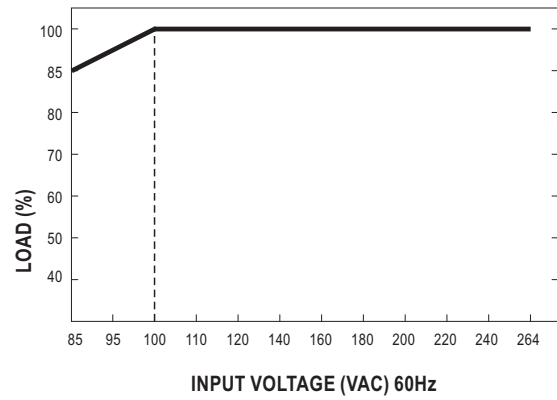

**Mechanical Specification**

Case No. GS120A Unit:mm

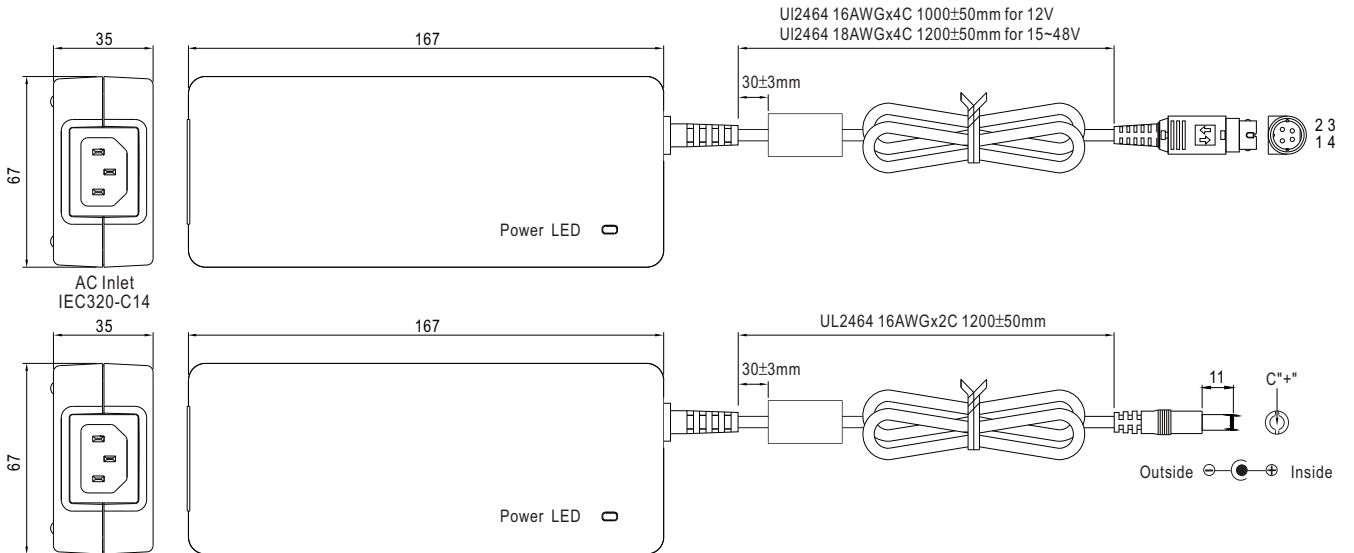











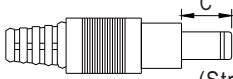
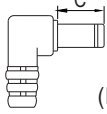

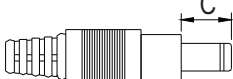
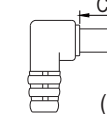

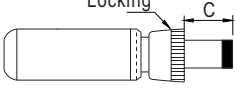
**DC output plug**

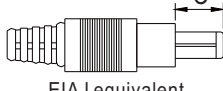
☉ Standard plug

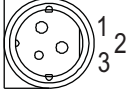
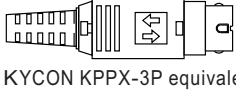
R7B		Pin Assignment		
	 2 3 1 4 KYCON KPPX-4P equivalent	 AC FG -V connected to AC FG	PIN NO.	OUTPUT
			1	+Vo
			2	-Vo
			3	-Vo
<b>P1M</b>		<b>Pin Assignment</b>		
 5.5 2.5 11±0.5mm		 C"+		
		Outside ⊖ ⊕ Inside -V connected to AC FG		

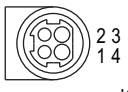
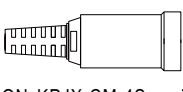
☉ Optional DC plug:

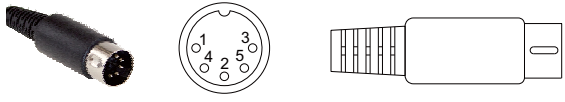
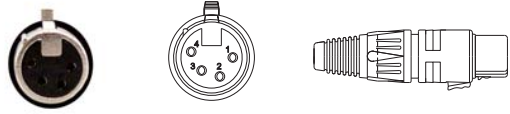
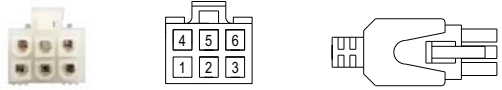
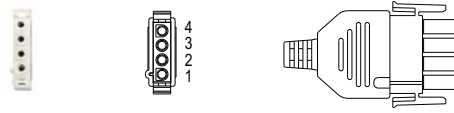
Tuning Fork Style		Type No.	A	B	C	
			OD	ID	L	
 	 (Straight)	P1I	5.5	2.1	9.5	
		P1J	5.5	2.1	11.0	
		P1L	5.5	2.5	9.5	
	 (Right-angled)	P1IR	5.5	2.1	9.5	
		P1JR	5.5	2.1	11.0	
		P1LR	5.5	2.5	9.5	
	P1MR	5.5	2.5	11.0		
Barrel Style		Type No.	A	B	C	
			OD	ID	L	
 	 (Straight)	P2I	5.5	2.1	9.5	
		P2J	5.5	2.1	11.0	
		P2L	5.5	2.5	9.5	
	 (Right-angled)	P2M	5.5	2.5	11.0	
		P2IR	5.5	2.1	9.5	
		P2JR	5.5	2.1	11.0	
		P2LR	5.5	2.5	9.5	
		P2MR	5.5	2.5	11.0	
Lock Style		Type No.	A	B	C	
			OD	ID	L	
   SWITCHCRAFT original	P2S(S761K)	5.53	2.03	12.06		
		P2K(761K)	5.53	2.54	12.06	
		P2C(S760K)	5.53	2.03	9.52	
		P2D(760K)	5.53	2.54	9.52	
Center Pin Style		Type No.	A	B	C	D
			OD	ID	L	Center Pin
   EIAJ equivalent	P4A	5.5	3.4	11.0	1.0	
		P4B	6.5	4.4	11.0	1.4
		P4C	7.4	5.1	11.0	0.6
Min. DIN 3 Pin with Lock (male)		Type No.	Pin Assignment			
			PIN No.	Output		
   KYCON KPPX-3P equivalent	R6B	1	+Vo			
			2	-Vo		
			3	+Vo		
Min. DIN 4 Pin with Lock (female)		Type No.	Pin Assignment			
			PIN No.	Output		
   KYCON KPJX-CM-4S equivalent	R7BF	1	+Vo			
			2	-Vo		
			3	-Vo		
			4	+Vo		

DIN 5 Pin (male)	Type No.	Pin Assignment	
		PIN No.	Output
	R1B	1	-Vo
		2	-Vo
		3	+Vo
		4	-Vo
		5	+Vo
NEUTRIK XLR NC4FX equivalent	Type No.	Pin Assignment	
	MIC4	PIN No.	Output
		1	+Vo
		2	+Vo
		3	-Vo
4	-Vo		
MOLEX 39-01-2060 (4.2mm) equivalent	Type No.	Pin Assignment	
 <p>FG not connected to output connector</p>	C6P	PIN No.	Output
		1	+Vo
		2	+Vo
		3	+Vo
		4	-Vo
		5	-Vo
6	-Vo		
AMP 1-480702-0 (6.35mm) equivalent	Type No.	Pin Assignment	
 <p>FG not connected to output connector</p>	C4P	PIN No.	Output
		1	+Vo
		2	+Vo
		3	-Vo
4	-Vo		
Stripped and tinned leads	Type No.	Pin Assignment	
 <p>Length of Land L1 by request (MW's standard length, L: <u>25</u> mm, L1: <u>5</u> mm)</p>	by customer	1	+Vo
		2	-Vo

**Installation Manual**

Please refer to : <http://www.meanwell.com/manual.html>