



■ **Features**

- Universal AC input / Full range
- 2 pole EURO plug, Class II power unit
- No load power consumption < 0.075W
- **Energy efficiency Level VI**
- Comply with EU ErP and meet CoC Version 5
- Protections: Short circuit / Overload / Over voltage
- Fully enclosed plastic case
- Pass LPS
- 2 years warranty

■ **Applications**

- Consumer electronic devices
- Telecommunication devices
- Office facilities
- Industrial equipments

■ **Description**

GS06E is a highly reliable, 6W wall-mounted style single-output green adaptor series. This product is a class II power unit (no FG), equipped with a 2-Pin standard European AC power plug, adopting the input range from 90VAC to 264VAC. The entire series supplies different models with output voltages ranging between 5VDC and 48VDC that can satisfy the demands for various types of consumer electronic devices. With the efficiency up to 84% and the extremely low no-load power consumption below 0.075W, GS06E is compliant with EU ErP, and meet Code of Conduct(CoC) Version 5. The supreme feature allows the adaptor to save the energy when it is either under the operating mode or the standby mode. The entire series utilizes the 94V-0 flame retardant plastic case, providing the double insulation that effectively prevents electrical shock. GS06E is certified for the international safety regulations.

■ **Model Encoding**

GS 06 E - 1 P1J

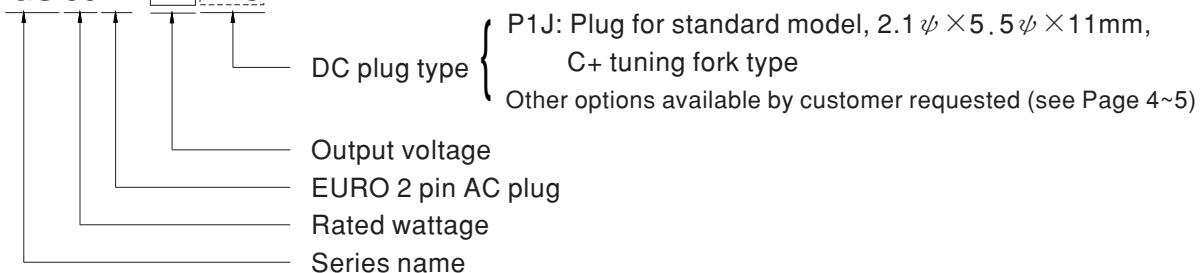

SPECIFICATION

| ORDER NO. | GS06E-1P1J | GS06E-11P1J | GS06E-2P1J | GS06E-3P1J | GS06E-4P1J | GS06E-5P1J | GS06E-6P1J | GS06E-8P1J | | |
|----------------------|--|--|---------------------------------------|------------|------------|------------|--|--|------------|--|
| OUTPUT | SAFETY MODEL NO. | GS06E-1 | GS06E-1-1 | GS06E-2 | GS06E-3 | GS06E-4 | GS06E-5 | GS06E-6 | GS06E-8 | |
| | DC VOLTAGE Note.2 | 5V | 7.5V | 9V | 12V | 15V | 18V | 24V | 48V | |
| | RATED CURRENT | 1.00A | 0.8A | 0.66A | 0.5A | 0.4A | 0.33A | 0.25A | 0.125A | |
| | CURRENT RANGE | 0 ~ 1.00A | 0 ~ 0.8A | 0 ~ 0.66A | 0 ~ 0.5A | 0 ~ 0.4A | 0 ~ 0.33A | 0 ~ 0.25A | 0 ~ 0.125A | |
| | RATED POWER | 5W | 6W | 6W | 6W | 6W | 6W | 6W | 6W | |
| | RIPPLE & NOISE (max.) Note.3 | 50mVp-p | 80mVp-p | 80mVp-p | 100mVp-p | 120mVp-p | 150mVp-p | 180mVp-p | 200mVp-p | |
| | VOLTAGE TOLERANCE Note.4 | ±5.0% | ±5.0% | ±5.0% | ±3.0% | ±3.0% | ±3.0% | ±2.0% | ±2.0% | |
| | LINE REGULATION Note.5 | ±0.5% | ±0.5% | ±0.5% | ±0.5% | ±0.5% | ±0.5% | ±0.5% | ±0.5% | |
| | LOAD REGULATION Note.6 | ±5.0% | ±5.0% | ±5.0% | ±3.0% | ±3.0% | ±3.0% | ±2.0% | ±2.0% | |
| | SETUP, RISE, HOLD UP TIME | 1000ms, 50ms, 12ms at full load | | | | | | | | |
| INPUT | VOLTAGE RANGE | 90 ~ 264VAC 127 ~ 370VDC | | | | | | | | |
| | FREQUENCY RANGE | 47 ~ 63Hz | | | | | | | | |
| | EFFICIENCY (Typ.) | 68% | 74% | 75% | 77% | 78% | 78% | 82% | 84% | |
| | AC CURRENT | 0.2A / 100VAC | | | | | | | | |
| | INRUSH CURRENT (max.) | Cold start 30A/ 115VAC 50A/ 230VAC | | | | | | | | |
| | LEAKAGE CURRENT(max.) | 0.25mA / 240VAC | | | | | | | | |
| PROTECTION | OVERLOAD | >105% rated output power for 5V ; >110% rated output power for 7.5 ~ 48V Protection type : Hiccup mode, recovers automatically after fault condition is removed | | | | | | | | |
| | OVER VOLTAGE | >120% rated output voltage Protection type : Clamp by zener diode | | | | | | | | |
| | ENVIRONMENT | WORKING TEMP. | 0 ~ +50°C (Refer to "Derating Curve") | | | | | | | |
| ENVIRONMENT | WORKING HUMIDITY | 20% ~ 90% RH non-condensing | | | | | | | | |
| | STORAGE TEMP., HUMIDITY | -20 ~ +85°C, 10 ~ 95% RH non-condensing | | | | | | | | |
| | TEMP. COEFFICIENT | ±0.03% / °C (0 ~ 40°C) | | | | | | | | |
| | VIBRATION | 10 ~ 500Hz, 2G 10min./1cycle, period for 60min. each along X, Y, Z axes | | | | | | | | |
| | SAFETY & EMC (Note. 7) | SAFETY STANDARDS | TUV EN60950-1, EAC TP TC 004 approved | | | | | | | |
| WITHSTAND VOLTAGE | | I/P-O/P:4242VDC | | | | | | | | |
| ISOLATION RESISTANCE | | I/P-O/P:100M Ohms / 500VDC / 25°C / 70% RH | | | | | | | | |
| EMC EMISSION | | Parameter | Standard | | | | | Test Level / Note | | |
| | | Conducted emission | EN55032(CISPR32) | | | | | Class B | | |
| | | Radiated emission | EN55032(CISPR32) | | | | | Class B | | |
| | | Harmonic current | EN61000-3-2 | | | | | Class A | | |
| | | Voltage flicker | EN61000-3-3 | | | | | ----- | | |
| EMC IMMUNITY | | Parameter | Standard | | | | | Test Level / Note | | |
| | | ESD | EN61000-4-2 | | | | | Level 3, 8KV air; Level 2, 4KV contact | | |
| | | RF field susceptibility | EN61000-4-3 | | | | | Level 2, 3V/m | | |
| | | EFT bursts | EN61000-4-4 | | | | | Level 2, 1KV | | |
| | | Surge susceptibility | EN61000-4-5 | | | | | Level 3, 1KV/L-N | | |
| | | Conducted susceptibility | EN61000-4-6 | | | | | Level 2, 3V | | |
| | | Magnetic field immunity | EN61000-4-8 | | | | | Level 1, 1A/m | | |
| | Voltage dips , interruption | EN61000-4-11 | | | | | >95% dip 0. 5 periods, 30% dip 25 periods, >95% interruptions 250 periods | | | |
| OTHERS | MTBF | 500Khrs min. MIL-HDBK-217F(25°C) | | | | | | | | |
| | DIMENSION | 32*66*42.5mm (L*W*H) | | | | | | | | |
| | PACKING | 100g ; 90pcs / 10Kg / CARTON | | | | | | | | |
| CONNECTOR | PLUG | See page 4~5 ; Other type available by customer requested | | | | | | | | |
| | CABLE | See page 4~5 ; Other type available by customer requested | | | | | | | | |
| NOTE | <p>1.All parameters are specified at 230VAC input, rated load, 25°C 70% RH ambient. 2.DC voltage: The output voltage set at point measure by plug terminal & 50% load. 3.Ripple & noise are measured at 20MHz by using a 12" twisted pair terminated with a 0.1µf & 47µf capacitor. 4.Tolerance: includes set up tolerance, line regulation, load regulation. 5.Line regulation is measured from low line to high line at rated load. 6.Load regulation is measured from 0% to 100% rated load 7.The power supply is considered as an independent unit, but the final equipment still need to re-confirm that the whole system complies with the EMC directives. For guidance on how to perform these EMC tests, please refer to "EMI testing of component power supplies." (as available on http://www.meanwell.com)</p> | | | | | | | | | |

■ Derating Curve

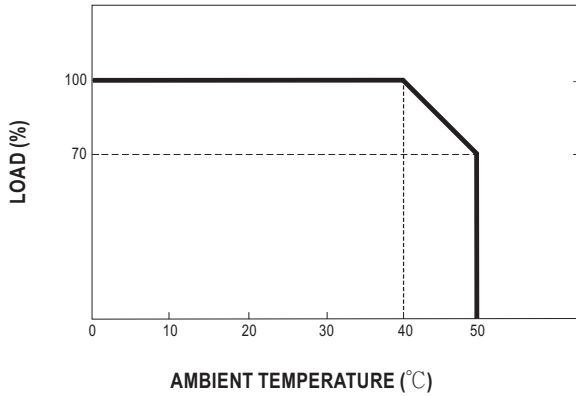

■ Static Characteristics

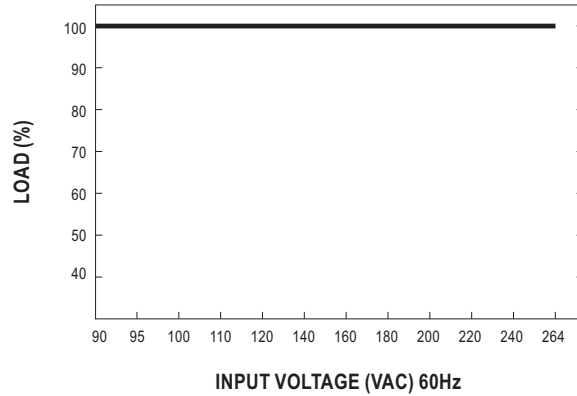

■ Mechanical Specification



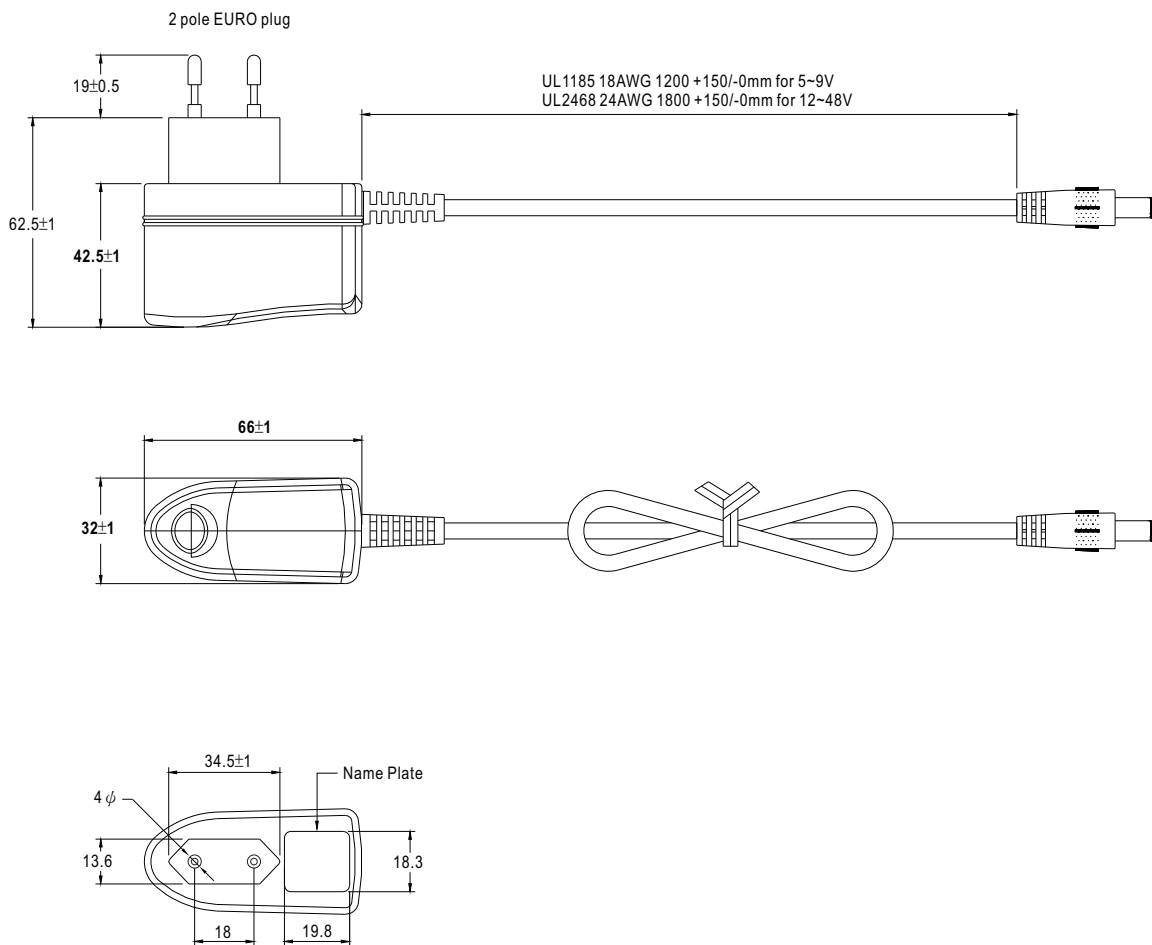

Unit:mm







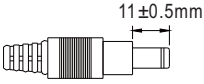



■ DC output plug

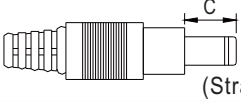
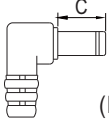

☉ Standard plug: P1J

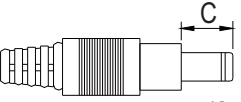
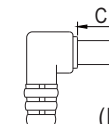
Unit:mm

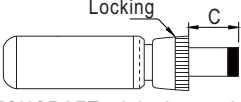
| P1J | | Pin Assignment |
|---|---|--|
|  |  |  |
| |  | Outside  Inside  |

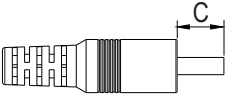
☉ Optional DC plug:

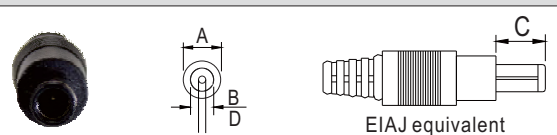
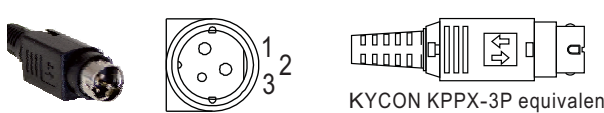
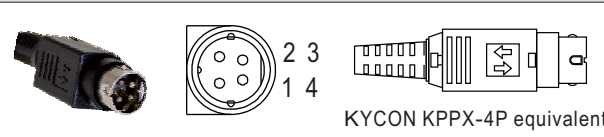
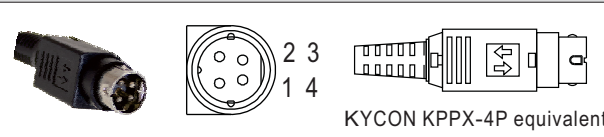
| Tuning Fork Style | | Type No. | A | B | C | |
|---|---|----------------|------|-------|------|------|
| | | | OD | ID | L | |
|   |  | P1I | 5.5 | 2.1 | 9.5 | |
| | (Straight) | P1L | 5.5 | 2.5 | 9.5 | |
| | P1M | 5.5 | 2.5 | 11.0 | | |
| |  | (Right-angled) | P1IR | 5.5 | 2.1 | 9.5 |
| | | P1JR | 5.5 | 2.1 | 11.0 | |
| | | P1LR | 5.5 | 2.5 | 9.5 | |
| | | P1MR | 5.5 | 2.5 | 11.0 | |
| Barrel Style | | Type No. | A | B | C | |
| | | | OD | ID | L | |
|   |  | P2I | 5.5 | 2.1 | 9.5 | |
| | (Straight) | P2J | 5.5 | 2.1 | 11.0 | |
| | P2L | 5.5 | 2.5 | 9.5 | | |
| |  | (Right-angled) | P2M | 5.5 | 2.5 | 11.0 |
| | | P2IR | 5.5 | 2.1 | 9.5 | |
| | | P2JR | 5.5 | 2.1 | 11.0 | |
| | | P2LR | 5.5 | 2.5 | 9.5 | |
| | | P2MR | 5.5 | 2.5 | 11.0 | |
| | | | | | | |
| Lock Style | | Type No. | A | B | C | |
| | | | OD | ID | L | |
|    <p>SWITCHCRAFT original or equivalent</p> | P2S(S761K) | 5.53 | 2.03 | 12.06 | | |
| | P2K(761K) | 5.53 | 2.54 | 12.06 | | |
| | P2C(S760K) | 5.53 | 2.03 | 9.52 | | |
| | P2D(760K) | 5.53 | 2.54 | 9.52 | | |
| | | | | | | |
| Min. Pin Style | | Type No. | A | B | C | |
| | | | OD | ID | L | |
|    <p>EIAJ equivalent</p> | P3A | 2.35 | 0.7 | 11.0 | | |
| | P3B | 4.0 | 1.7 | 11.0 | | |
| | P3C | 4.75 | 1.7 | 11.0 | | |
| | | | | | | |

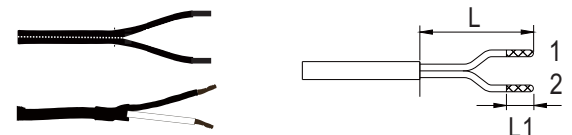
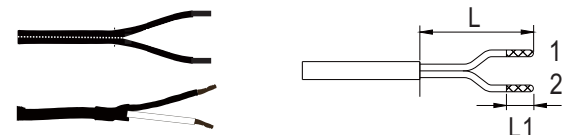
| Center Pin Style | Type No. | A | B | C | D | | |
|---|-------------|--|----------|----------------|------------|--|--|
| | | OD | ID | L | Center Pin | | |
|  <p>EIAJ equivalent</p> | P4A | 5.5 | 3.4 | 11.0 | 1.0 | | |
| | P4B | 6.5 | 4.4 | 11.0 | 1.4 | | |
| | P4C | 7.4 | 5.1 | 11.0 | 0.6 | | |
| Min. DIN 3 Pin with Lock (male) | Type No. | Pin Assignment | | | | | |
|  <p>KYCON KPPX-3P equivalent</p> | R6B | PIN No. | Output | | | | |
| | | 1 | +Vo | | | | |
| | | 2 | -Vo | | | | |
|  <p>KYCON KPPX-4P equivalent</p> | R7B | PIN No. | Output | | | | |
| | | 1 | +Vo | | | | |
| | | 2 | -Vo | | | | |
| 3 | | -Vo | | | | | |
|  <p>KYCON KPPX-4P equivalent</p> | R7B | 4 | +Vo | | | | |
| | | Min. DIN 4 Pin with Lock (female) | Type No. | Pin Assignment | | | |
| | |  <p>KYCON KPJX-CM-4S equivalent</p> | R7BF | PIN No. | Output | | |
| | | | | 1 | +Vo | | |
| 2 | -Vo | | | | | | |
| 3 | -Vo | | | | | | |
|  <p>KYCON KPJX-CM-4S equivalent</p> | R7BF | 4 | +Vo | | | | |
| | | Stripped and tinned leads | Type No. | Pin Assignment | | | |
|  <p>Length of Land L1 by request (MW's standard length, L: <u>25</u> mm, L1: <u>10</u> mm)</p> | by customer | PIN No. | Output | | | | |
| | | 1 (Ribbed or White) | +Vo | | | | |
|  <p>Length of Land L1 by request (MW's standard length, L: <u>25</u> mm, L1: <u>10</u> mm)</p> | by customer | 2 (Letter or Black) | -Vo | | | | |

■ **Installation Manual**

Please refer to : <http://www.meanwell.com/manual.html>